

# Fiche de donnees

## Description

Reduction concentrique, DIN2616/  
EN10253-2-B, P235GH,  
cert. EN10204/3.1

## Donnee principale

168.30 x 5.60 / 88.90 x 4.00

D	168.30 mm
S1	5.60 mm
d	88.90 mm
S2	4.00 mm
L	140.00 mm

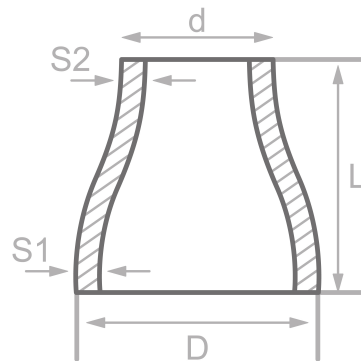

## Composition chimique (analyse de lot) en % de la masse

(Limite superieure si une seule valeur est specifiee)

Nom court: P235GH

Numero: 1.0345

C	Si	Mn	P	S	Cr	Cu	Mo	Nb	Ni	Ti	V	Autres
0.16	0.35	1.20	0.025	0.020	0.30	0.30	0.08	0.01	0.30	0.04	0.02	Al

## Proprietes mecaniques

Nom court: P235GH

Numero: 1.0345

Limite d'elasticite superieure ou lim. d'elast. reH ou Rp0,2 min pour epaisseurs T en mm, N/mm2 a temperature ambiante		Resist. a la traction Rm pour des ep. T en mm, N/mm2 a temperature ambiante		Allongement A a temp. ambiante, min.%		Travaux a impact minimum KV en J	
T<=16	16<T<=60	T<=16	16<T<=60	Longit.	Transv.	Longit.	Transv.
235	225	360-500	360-500	25	23	40	27

Sources: EN 10253, DIN 17175, DIN 2528, DIN 1629, Stahlschlüssel, ASTM