

Fiche de donnees

Description

Reduction concentrique, DIN2616/
EN10253-2-B, P235GH,
cert. EN10204/3.1

Donnee principale

273.00 x 8.80 / 139.70 x 6.30

D	273.00 mm
S1	8.80 mm
d	139.70 mm
S2	6.30 mm
L	178.00 mm

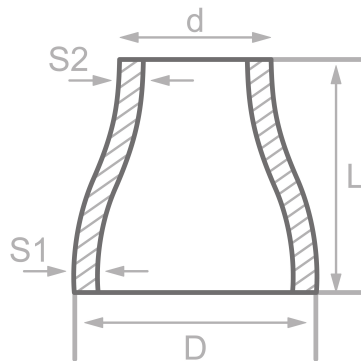

Composition chimique (analyse de lot) en % de la masse

(Limite superieure si une seule valeur est specifiee)

Nom court: P235GH

Numero: 1.0345

C	Si	Mn	P	S	Cr	Cu	Mo	Nb	Ni	Ti	V	Autres
0.16	0.35	1.20	0.025	0.020	0.30	0.30	0.08	0.01	0.30	0.04	0.02	Al

Proprietes mecaniques

Nom court: P235GH

Numero: 1.0345

Limite d'elasticite superieure ou lim. d'elast. reH ou Rp0,2 min pour epaisseurs T en mm, N/mm2 a temperature ambiante		Resist. a la traction Rm pour des ep. T en mm, N/mm2 a temperature ambiante		Allongement A a temp. ambiante, min.%		Travaux a impact minimum KV en J	
T<=16	16<T<=60	T<=16	16<T<=60	Longit.	Transv.	Longit.	Transv.
235	225	360-500	360-500	25	23	40	27

Sources: EN 10253, DIN 17175, DIN 2528, DIN 1629, Stahlschlüssel, ASTM