

# Datasheet

## Description

Conc. red., DIN2616/EN10253-2-B  
P265GH, certificate 3.1

## Main data

33.70 x 3.20 / 26.90 x 3.20 mm

D	33.70 mm
S1	3.20 mm
d	26.90 mm
S2	3.20 mm
L	50.00 mm

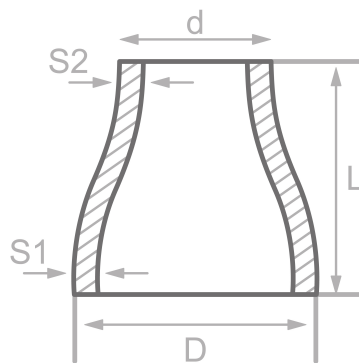

## Chemical analysis (heat) in % of mass

(one content=max. value)

Short name: P265GH

Mat. grade: 1.0425

C	Si	Mn	P	S	Cr	Cu	Mo	Nb	Ni	Ti	V	Others
0.20	0.40	1.40	0.025	0.020	0.30	0.30	0.08	0.01	0.30	0.04	0.02	Al

## Mechanical properties

Short name: P265GH

Mat. grade: 1.0425

Upper yield strength reH or Rp0.2 min for wallthicknesses T in mm, N/mm2 at room temperature		Tensile strength Rm for wallthickn. T in mm, N/mm2 at room temperature		Elongation A at room- temperature, min.%		Min. impact energy KV in J	
T<=16	16<T<=60	T<=16	16<T<=60	Longit.	Transv.	Longit.	Transv.
265	255	410-570	410-570	23	21	40	27

Sources: EN 10253, DIN 17175, DIN 2528, DIN 1629, Stahlschlüssel, ASTM

