

# Datasheet

## Description

Elbows, ANSI/ASME B16.9, LR, 90°  
ASTM A234 WPB, certificate 3.1

## Main data

Type 3/LR, 8" s. 60

D	219.10 mm
S	10.31 mm
r	305.00 mm

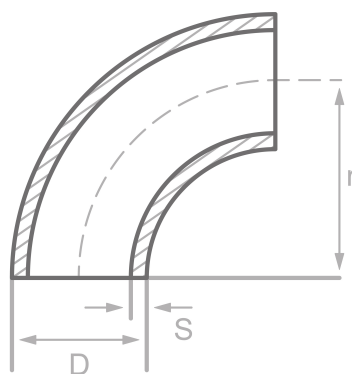

## Chemical analysis (heat) in % of mass

(one content=max. value)

Short name: WPB

Mat. grade: ----

C	Si	Mn	P	S	Cr	Cu	Mo	Nb	Ni	Ti	V	Others
0.30	0.10	1.06	0.048	0.058	0.40	0.40	0.15		0.40		0.08	

## Mechanical properties

Short name: WPB

Mat. grade: ----

Upper yield strength reH or Rp0.2 min for wallthicknesses T in mm, N/mm2 at room temperature		Tensile strength Rm for wallthickn. T in mm, N/mm2 at room temperature		Elongation A at room- temperature, min.%		Min. impact energy KV in J	
T<=16	16<T<=60	T<=16	16<T<=60	Longit.	Transv.	Longit.	Transv.
240	240	min. 415	min. 415	30	17		

Sources: EN 10253, DIN 17175, DIN 2528, DIN 1629, Stahlschlüssel, ASTM